

Duramax® 180° mini machine torch parts

For use with the Powermax65®



Duramax 180° mini torch assembly

Item	Kit/Part number	Description
	059481	Duramax 180° mini machine torch assembly with 4.5 m (15') lead
	059482	Duramax 180° mini machine torch assembly with 7.6 m (25') lead
	059483	Duramax 180° mini machine torch assembly with 10.7 m (35') lead
	059484	Duramax 180° mini machine torch assembly with 15.2 m (50') lead
3	220956	Kit: Duramax 180°/Duramax 180° mini torch front mounting sleeve
4	228736	Kit: Duramax 180°/Duramax 180° mini torch adapter ring (coupler)
5	228716	Kit: Duramax 180°/Duramax 180° mini torch main body replacement
6	228720	Kit: Cap-sensor switch replacement
7	058519	O-ring
8	075504	Pilot terminal screw
9	228730	Kit: Duramax 180°/Duramax 180° mini torch lead replacement, 4.5 m (15')
9	228731	Kit: Duramax 180°/Duramax 180° mini torch lead replacement, 7.6 m (25')
9	228732	Kit: Duramax 180°/Duramax 180° mini torch lead replacement, 10.7 m (35')
9	228733	Kit: Duramax 180°/Duramax 180° mini torch lead replacement, 15.2 m (50')
9	228734	Kit: Duramax 180°/Duramax 180° mini torch lead replacement, 22.8 m (75')
	128650	Remote start pendant for machine torch, 7.6 m (25')
	128651	Remote start pendant for machine torch, 15.2 m (50')
	128652	Remote start pendant for machine torch, 22.8 m (75')
	223125 ¹	Kit: 65 A Work lead with hand clamp, 7.6 m (25')

¹Other work lead options available.

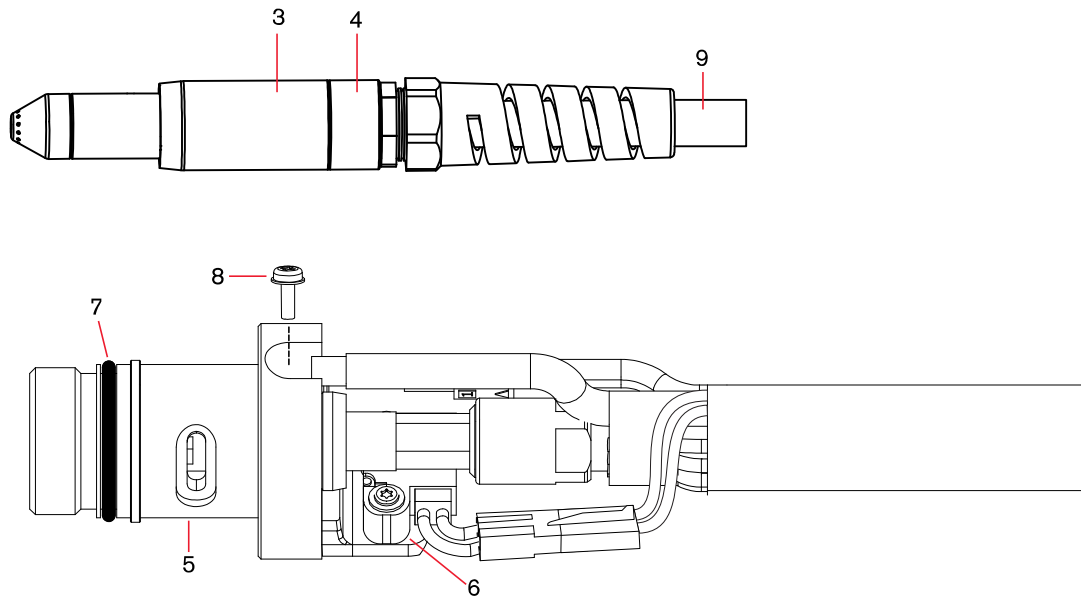

See pages 64–65 for current system part number information.