

Duramax® 15° hand torch parts

For use with the Powermax85®



Duramax 15° hand torch assembly

Item	Kit/Part number	Description
	059470	Duramax 15° hand torch assembly with 7.6 m (25') lead
	059471	Duramax 15° hand torch assembly with 15.2 m (50') lead
	059472	Duramax 15° hand torch assembly with 22.8 m (75') lead
1	228955	Kit: Duramax 15° Torch handle replacement
2	075714 ¹	Handle screws, #4 x 1/2 slotted TORX pan head, S/B
3	228721	Kit: Duramax 15°/Duramax 75°/HRT/HRTs (spring and trigger assembly)
4	228715 ¹	Kit: Duramax 15° Torch main body replacement (3/8" coupler)
4	228957 ¹	Kit: Duramax 15° Torch main body replacement (1/2" coupler)
5	058519	O-ring
6	228109	Kit: Duramax 15° Cap-sensor switch replacement
7	228959 ¹	Kit: Duramax 15° Torch lead replacement, 7.6 m (25')
7	228960 ¹	Kit: Duramax 15° Torch lead replacement, 15.2 m (50')
7	228961	Kit: Duramax 15° Torch lead replacement, 22.8 m (75')
	223035 ²	Kit: 85 A Work lead with hand clamp, 7.6 m (25')

¹Before ordering these parts verify the date the torch was built.

²Other work lead options available.

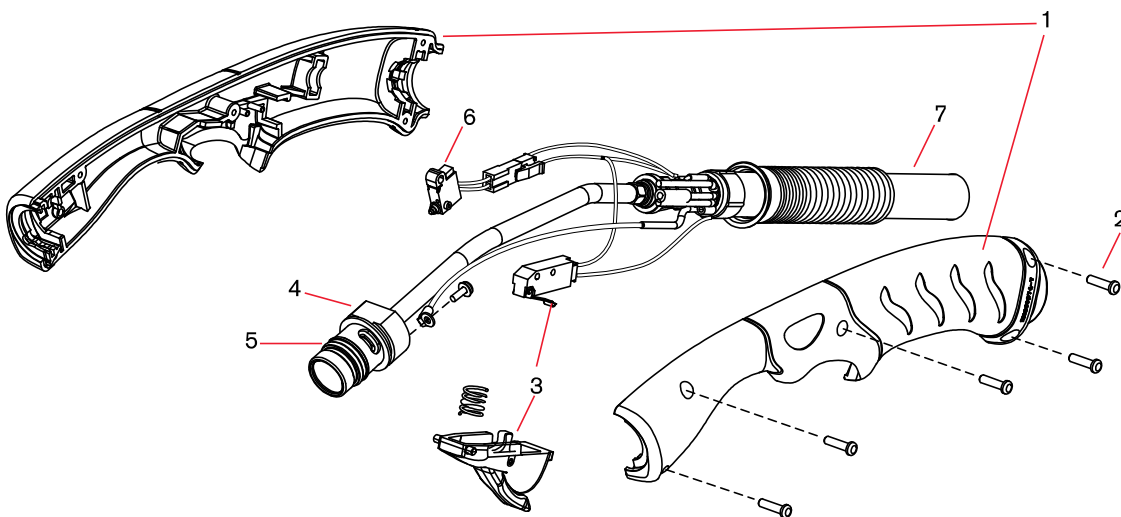

See pages 64–65 for current system part number information.