

Duramax® 90° robotic torch parts

For use with the Powermax85®



Duramax 90° robotic torch assembly

The entire Duramax 90° robotic torch assembly with leads can be replaced, or individual component parts can be replaced.

Item	Kit/Part number	Description
	059465	Duramax 90° robotic torch assembly with 7.6 m (25') lead
	059586	Duramax 90° robotic torch assembly with 15.2 m (50') lead
1	058519	O-ring
2	075504	Pilot terminal screw
3	075714	#4 x 1/2 slotted TORX pan head screws
4	228109	Kit: Cap-sensor switch replacement
5	428260	Kit: FastConnect replacement
6	228852	Kit: Robotic torch lead replacement, 7.6 m (25')
7	228854	Kit: 90° Robotic torch main body replacement
8	228857	Kit: 90° Robotic torch positioning barrel replacement
	228806	Kit: Robotic torch clamp assembly

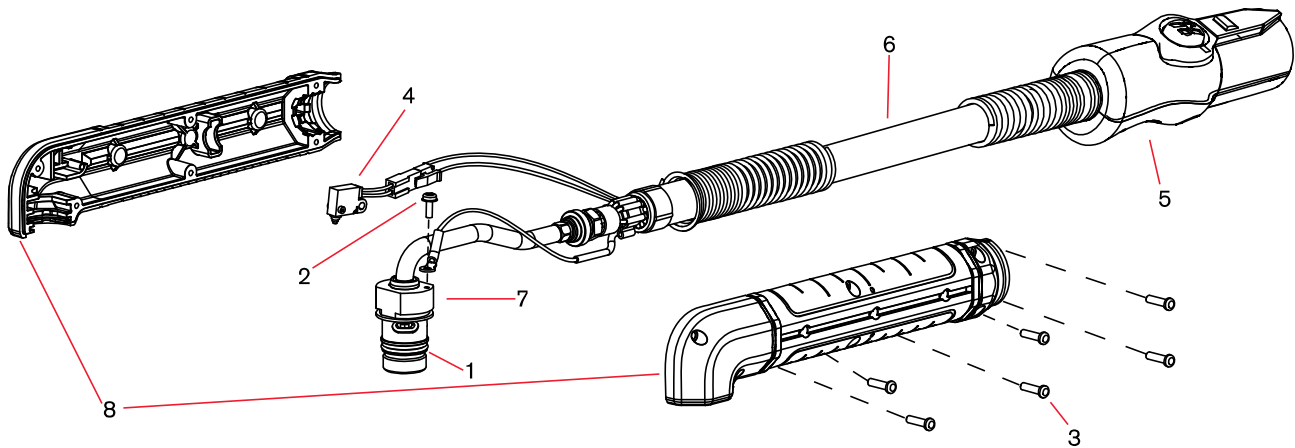

See pages 64–65 for current system part number information.